

3.色々なワークに対応 ワークハンド

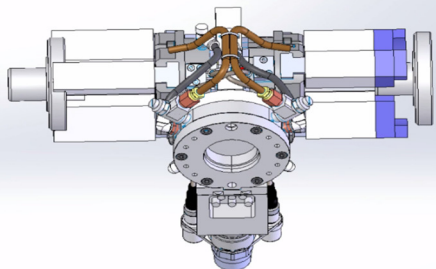

ダブルハンド LG-6
把握力 1000Nm



色々なワークを掴み分けるマルチハンド

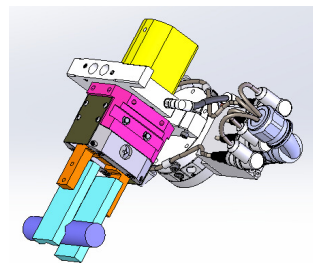
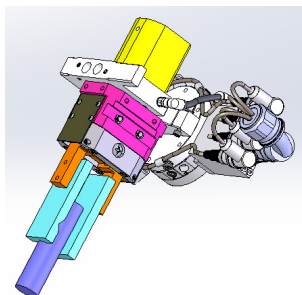

丸材把握

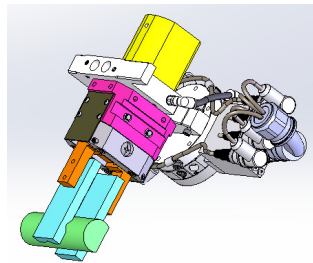
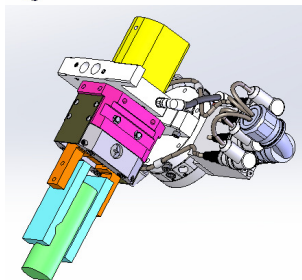

Dカット材把握

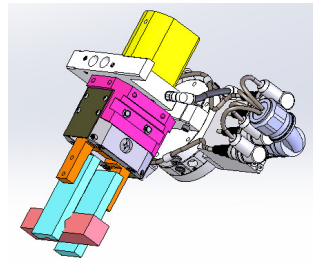
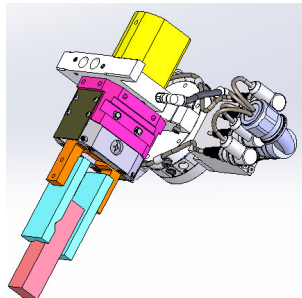

四角材把握

ダブルハンド LC-8
40mmロングストローク
AI035用

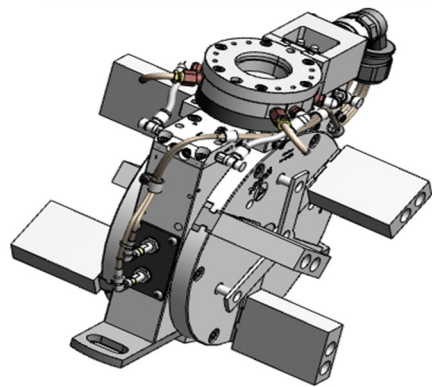

26mmのロングストロークダブルハンド

